



Intelligent Digital Pressure Gauge

1. Description

Digital pressure gauge is full electronic-structure and battery-powered, which make it very easy for on-site installation. Specifically, a high-precision piezo-resistive pressure sensor is used and the output signal is processed by the high-precision, low temperature drifting amplifier, then sent into the high-precision A/D converter to be converted into digital signal, after being computed and processed, the actual pressure value is showed on the LCD screen. It has benefits: flexible use, simple operation, easy debugging, safe, reliable etc. It is being widely used to measure and display the pressure of the medium in hydro-power, water, petroleum, chemical, mechanical, hydraulic and other industries.



REF. UL / FM

2. Features

- ◆ Size 100mm, stainless steel case,
- ◆ Large-screen LCD display, high resolution, back light, easy to read
- ◆ Automatically record the maximum pressure values during the measurement
- ◆ Pressure on the percentage of dynamic display, (the progress bar display)
- ◆ 10 engineering units: psi, bar, kpa, Mpa, Kgf(kgf / cm²), MMH(mmH₂O), MH₂(mH₂O),
- ◆ 0 ~ 15min auto-shut off feature.
- ◆ Micro-power consumption, over 2 years in power-saving mode, continuous work 2,000 hours
- ◆ Parameter correction, correct zero and error in field application.
- ◆ Pressure range already setted before use
- ◆ Sampling rate: 4 times / sec
- ◆ Applicable to gases and liquids compatible with stainless steel

3. Technical Parameters:

Pressure range	0-100MPa	Accuracy	0.50%
Overload capacity	200%	Pressure type	Gauge pressure
Stability	≤0.1% /year	Battery voltage	9VDC
Display	LCD	Display range	-19999~99999
Ambient temperature	-20℃~70℃	Relative humidity	≤80%
Mounting thread	M20*1.5 G1/2	Interface Material	Stainless Steel

4. Installation



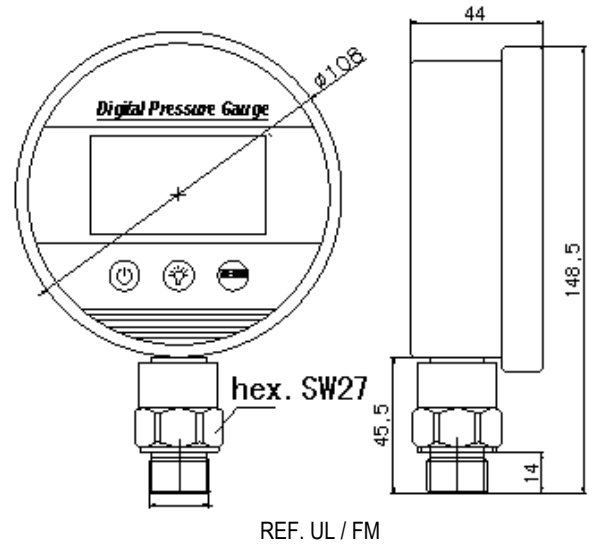

It can be directly mounted in the hydraulic pipe on the road through the mounting thread. In critical applications (such as severe vibration or shock), soft hose is recommended to connect the digital pressure gauge to reduce the effect caused by the severe vibrations and shocks.

5. Dimension



6. Operation Description







Button and its function

- ◆ “” button: to confirm
- ◆ “” button: to shift (for example, from 0000 to 0000)
- ◆ “ZERO” button: to add
- ◆ Open/close press gauge: short press “” button
- ◆ Open/close back light: short press “” button
- ◆ Shift engineering unit: long press “” button
- ◆ Clear the peak value: short press “ZERO” button

Some setting menus

- ◆ **lcmd**: password input menu, input password 0001
- ◆ **offt**: auto-shut off time menu, available time, 00~15 minutes, 00 means no auto-shut off function.
- ◆ **bclt**: back light time menu, available time, 00~15 minutes, 00 means no back light function.
- ◆ **end-**: exit menu, 0 or 1.0 means exiting without keeping the previous setting records, 1 means exiting with keeping the previous setting records.

How to set

1. Long press “” button, when “lock” shows in the small screen, input 00001, then press “” button to confirm, then into menu-setting situation.
2. Press “” button to choose the menu,
3. Press “” button to get the permission to change the value (when the digit is flashing),
4. Short press “” button and “ZERO” button to change the value,
5. Short press “” button to confirm the change (when the digit stops flashing)
6. Choose “end-” menu and press “” button to confirm, then keep or not keep the change.

7. User notes

1. Stored and used in the temperature of $-10^{\circ}\text{C} \sim 60^{\circ}\text{C}$ and the relative humidity less than 80%.
2. Should be concentric and parallel when connect digital pressure gauge and pressure system.
3. Please use 9V alkaline battery (6LR61) when replace the battery.

8. Warranty

Under right application and protection conditions, we offer the 1 year warranty since the date of the factory and after this the repair will be done in the company but not free.